

440

425~495

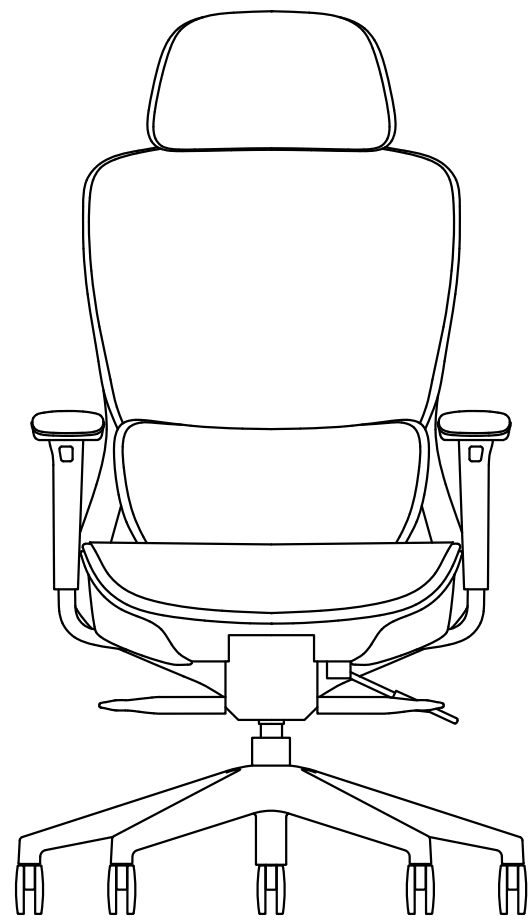

440~520

675

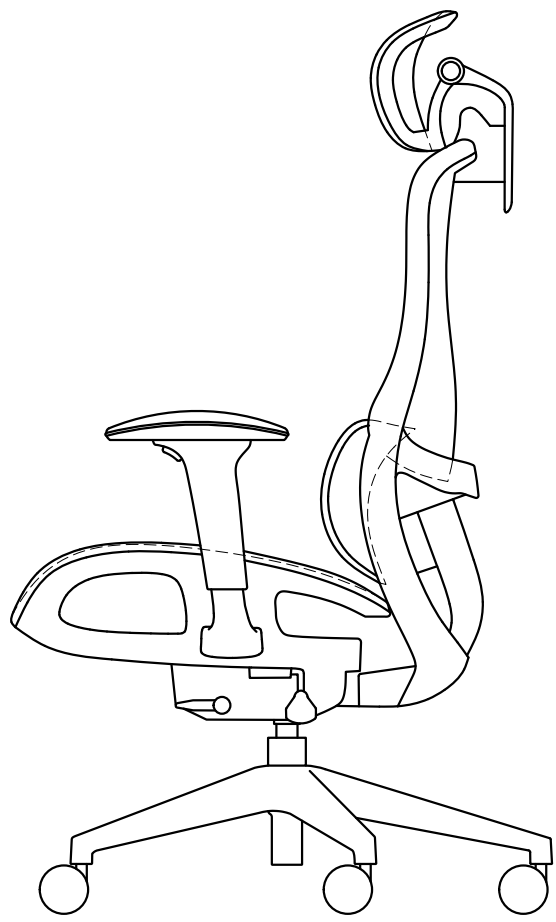

665~825

1165~1305

710~780