

396

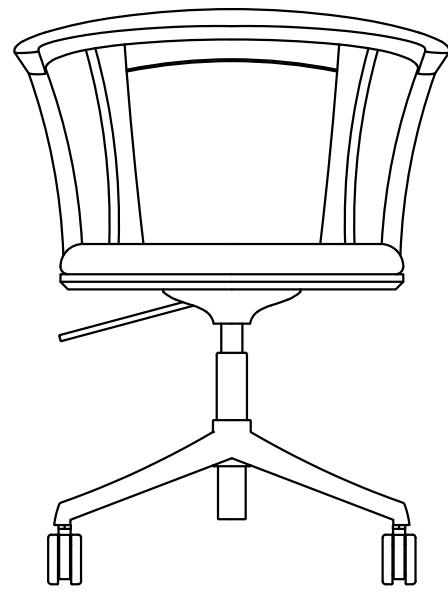

435~535

576

425

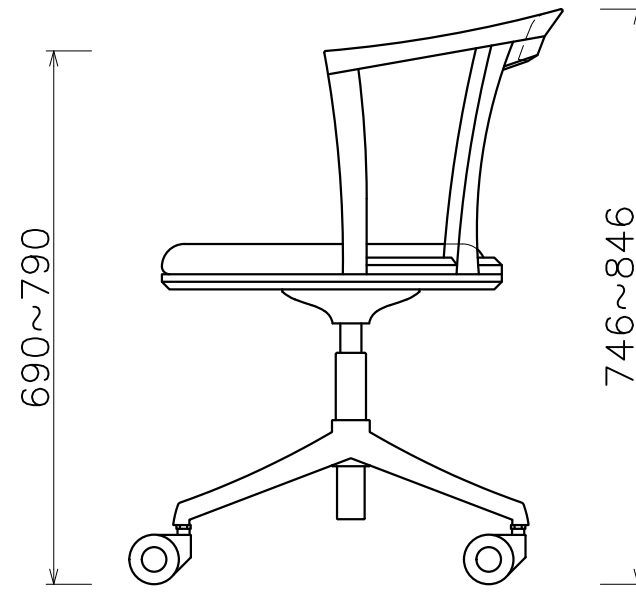

690~790

573

746~846